

Installation Guide

For HyPanel



Welcome!

This guide applies to PS51-PoE-EU , PS51V2-PoE-EU model of HyPanel.

Contents

Before We Start	2
In the Box	3
Check Compatibility	4
Wiring	7
Installation	10
Get Help	14

Before We Start

Your first time installing this product may take up to 40 minutes.

You'll get faster after each installation.



Warning!

Keep the device and all its parts out of the reach of children. The small parts or accessories contained may be a choking hazard to them.

In The Box

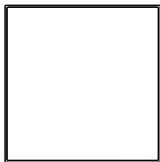

HyPanel X 1



M3x20mm Phillips Self Tapping
Screw **x2**

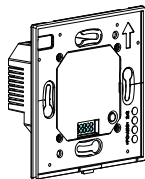

Flush Mounted Module **x1**

Check Compatibility

Product specifications

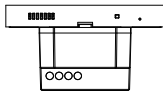

⑤ BOTTOM VIEW

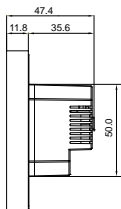

② RIGHT VIEW

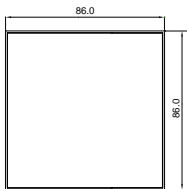

① FRONT VIEW

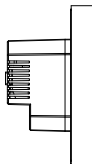

③ LEFT VIEW

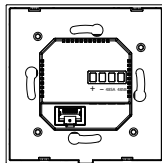

④ BACK VIEW

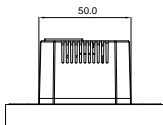

⑥ TOP VIEW

Working space

Make sure the HyPanel is compatible with the location where you want to install it.

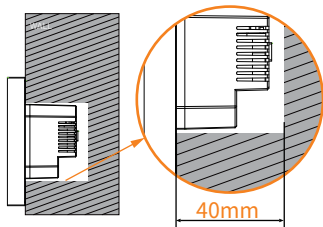
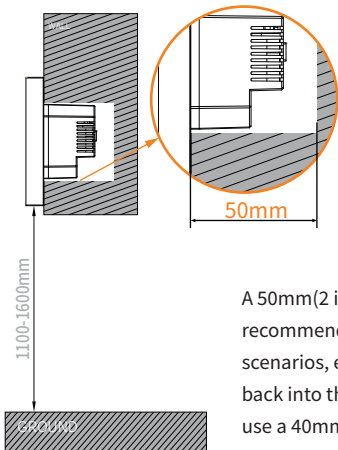

A 50mm(2 inches) deep electrical box is highly recommended for ease of installation. In some scenarios, especially when the wires can be pushed back into the wall far enough, it may be possible to use a 40mm(1.6 inches) deep box.

PoE or DC power input

HyPanel can be powered by either IEEE802.3af standard PoE or 12-24V DC.

Support Wi-Fi and Ethernet connections

HyPanel can operate with both wireless and wired networks, the use of the wired connection is recommended for greater reliability and speed of data exchange.

Wiring

Identify wires

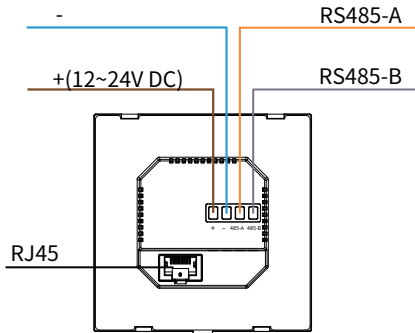

A positive DC wire(+) is often brown or red, and provides 12 -24 Volts of power to the device.

A negative DC wire(-) is often blue or black.

The RJ45 cable connecting with a PoE switch carries both data and power to the device, while the RJ45 with a non-PoE switch provides only Ethernet.

RS485_A and RS485_B are two signal lines used to connect third-party devices to HyPanel. NO need to connect to these two terminals if you' re not using third-party devices with RS485 communications.

Connect wires

1 Strip and straighten wires



The wires used for 12-24V DC power supplier or RS485 communication should be $1.5\text{mm}^2 \sim 2.5\text{mm}^2$ in size and have stripped and straight ends.

Strip the wires by removing the plastic sheathing, and make sure the exposed wire ends measure approximately 8mm (5/16 inch) in length.

2 Connect all wires

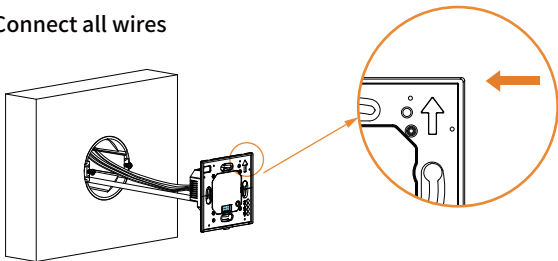

Always make sure the arrow on the front of the flush mounted module is pointing up.

- ◆ **If you want to power the device using PoE**

Plug the RJ45 Ethernet cable to the PoE port so that the module can receive both data and power.

- ◆ **If you want to power the device with 12-24V DC**

Plug the positive and negative DC wires to the corresponding terminals respectively.

Tighten the screws clockwise with a flat-head screwdriver until wires are secure.

Double check by gently tugging on each wire.

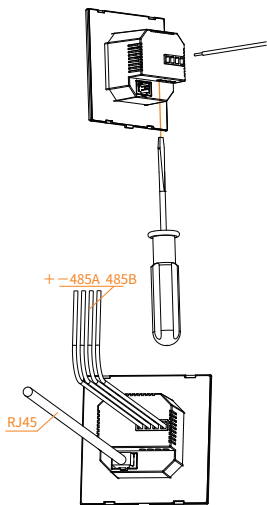

- ◆ **If you need to connect to third-party devices over RS485**

Connect RS485_A and RS485_B wires to the corresponding terminals.

Installation

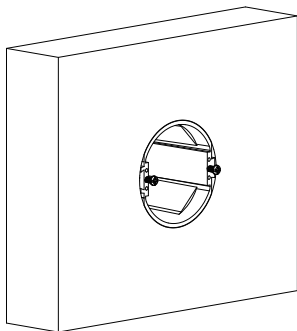

- ◆ Change the torque on the electric screwdriver to 5kgf.cm.
- ◆ Turn screws clockwise with the screwdriver.
- ◆ Do not fully tighten the screws. The screw head must protrude at least 3 mm (1/8 inch) from the wall surface.

1 Install flush mounted module

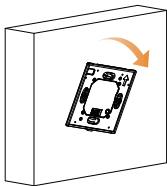

Attach the flush mounted module to the electrical box. The screws should go through the holes on the module.

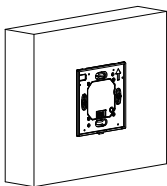

- ◆ Adjust the module to be level and ensure it is flush against the wall.
- ◆ Tighten the screws to attach the module to the wall, taking care not to over-tighten them.

2 Install panel

After installing the flush mounted module, you can start securing the panel.

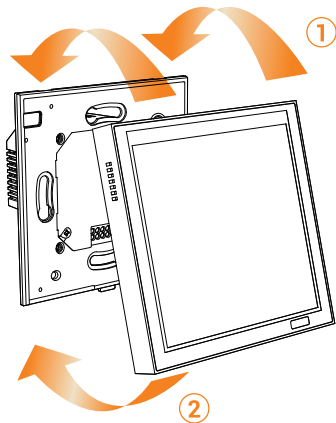

- Position the panel at a tilt as the image shows.
- Press the panel into the flush mounted module until it clicks.

If you need to remove the panel

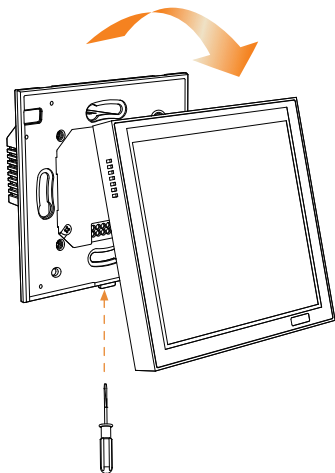

- ◆ Insert a flat-head screwdriver with about 6mm width into the slot at the bottom edge.
- ◆ Gently pry the panel up.

Get Help

For help or more assistance,
contact us at: <https://ticket.akuvox.com/>

For videos, guides, and additional product formation,
visit us at: <https://knowledge.akuvox.com>

Congratulations!

You are done with the HyPanel installation!

Start your smart home journey with Akubela now!





YS51000029